



# ***XIBU Tips and Tricks***

**eng**

*January 2018*



# Content

## **XIBU TISSUEPAPER**

Technical package .....	4
Replacing the cover assembly.....	5
Change the lid clip .....	6

## **XIBU senseFOAM / XIBU senseDISINFECT / XIBU senseDISHES / senseSEATCLEANER**

Technical package .....	7
Replacing the cover assembly.....	8
Replacing the potentiometer axis .....	9
Battery tray assembly .....	9
Changing the soap/disinfect tank .....	10

## **XIBU senseSEATCLEANER / XIBU senseMOISTCARE / XIBU touchSEATCLEANER**

Technical package .....	11
Replacing the cover assembly .....	12

## **XIBU touchFOAM**

Technical package .....	13
Replacing the technical package assembly .....	14

## **XIBU touchSEATCLEANER**

Technical package .....	15
Replacing the technical package assembly .....	16

## **XIBU senseTOWEL**

Technical package .....	17
Replacing the cover assembly.....	18-19
Cover microswitch .....	20
Replacing the battery tray .....	21
Tensioning roller spring .....	22
Replacing the cutting unit assembly .....	23-24
Replacing the lower counter roller / ESD film installation .....	25-26
Replacing the top counter roller .....	27-28

## **XIBU touchTOWEL**

Technical package .....	29
Replacing the cover assembly.....	30-31
Tensioning roller spring .....	32
Insert spring .....	33
Replacing the cutting unit assembly .....	34-35
Exchange the spring time interval .....	36

## **XIBU senseFRESHAIR**

Replacing the AF adjustment pin .....	37
Replacing the technical package assembly / Battery tray assembly .....	38

## **XIBU XL senseFLUID**

Technical package .....	39
Replacing the technical package assembly .....	40

## **Installation of various XIBU dispensers using two-sided adhesive tape**

Foam/Disinfect, SEATCLEANER, senseMOISTCARE, tissuePAPER.....	41
FRESHAIR, MULTIFOLD, XIBU XL senseFLUID.....	42-43

## **Installation of various XIBU dispenser on mirrors**

Screw mounting of XIBU dispensers on mirrors .....	44
--	----

## Checklist for troubleshooting on site

**This checklist serves as an aid for the fast detection of malfunctions and signs of wear in the dispensers and, if possible, for carrying out on-the-spot repairs.**

**The overriding principle must be that dispensers have to be repaired on site and that only hopeless cases are dismantled and sent to the headquarters.**



XIBU senseSEATCLEANER  
XIBU senseMOISTCARE

### Batch number

The batch number for 20 January 2012 is formed as follows:

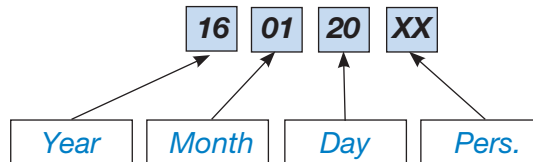

 The batch number is printed on the respective dispenser here



XIBU touchMULTIFOLD

### Batch-number

Since 14.9.2016 printed on all dispensers. The batch number is formed as follows: For example the date 17.09.2019.

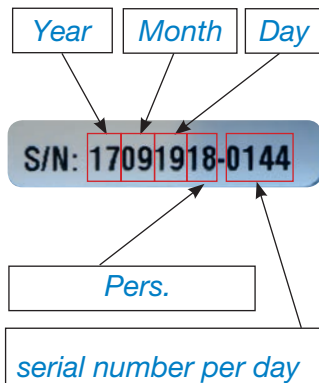

serial number per day



XIBU XL senseFLUID



XIBU touchSEATCLEANER

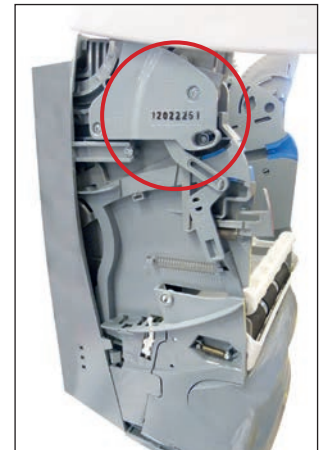

XIBU senseTOWEL  
XIBU touchTOWEL



XIBU touchTISSUEPAPER



XIBU senseFRESHAIR

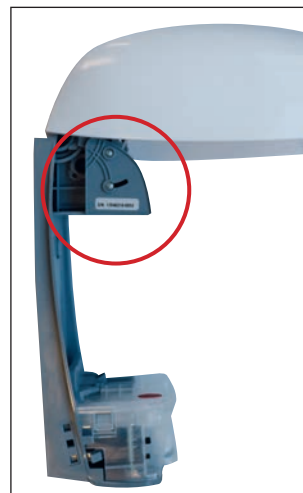

XIBU senseFOAM  
XIBU senseDISINFECT  
XIBU senseDISHES



XIBU touchFOAM

## XIBU TISSUEPAPER



### *XIBU touch*TISSUEPAPER

Article no.  
**411010065000**

Abb. 1: XIBU touchTISSUEPAPER

### Technical package



Abb. 2: XIBU touchTISSUEPAPER Technical package



Spare part name:  
*XIBU touch*TISSUEPAPER techn. package

Article no.  
**492011730000**

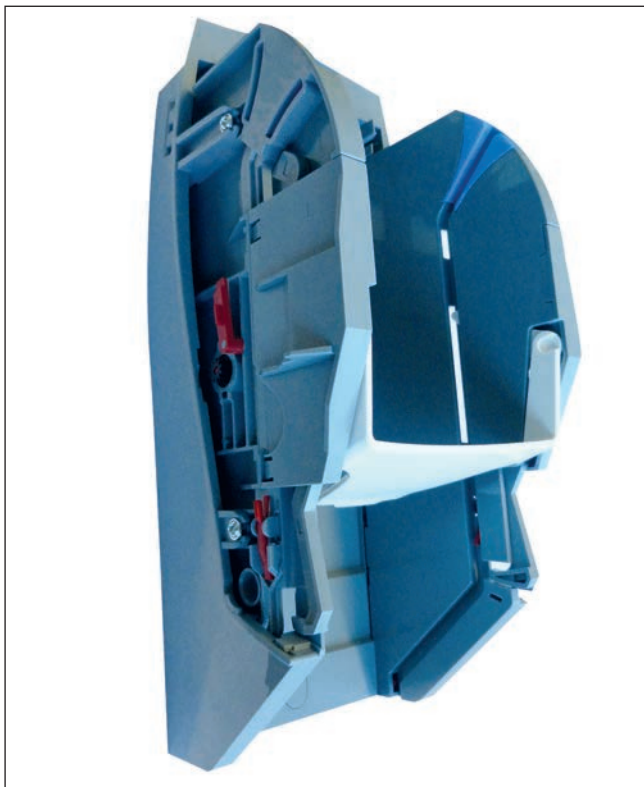
## Replacing the cover assembly



Fig. 1: Cover assembly

### Replacing the cover assembly

Open the dispenser with the XIBU key.

Press the red (grey) locking lever on the left side wall (Fig. 2) and slide it upwards (Fig. 3).

Press the right side of the cover lightly to the outside so that the cover can be turned to the side wall via the latch (Fig. 5).

Turn the cover down and then remove it from the pivot on the side wall (Fig. 6).



Fig. 2

Fig. 3

Remove the gear rack from the gear. (Fig. 4)

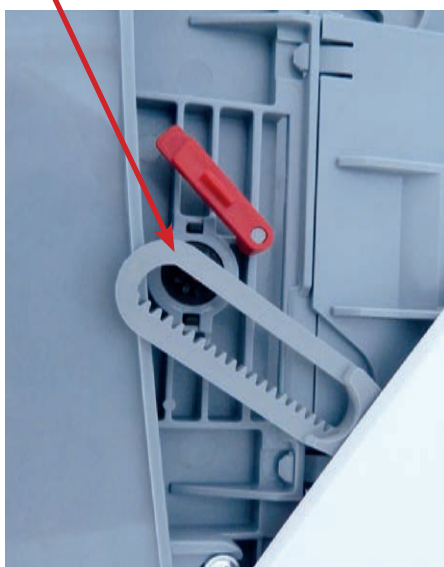

Fig. 4

Spare part name:  
WC cover white XIBU

Article no.  
492011620000

The installation of the new cover takes place in the reverse order!

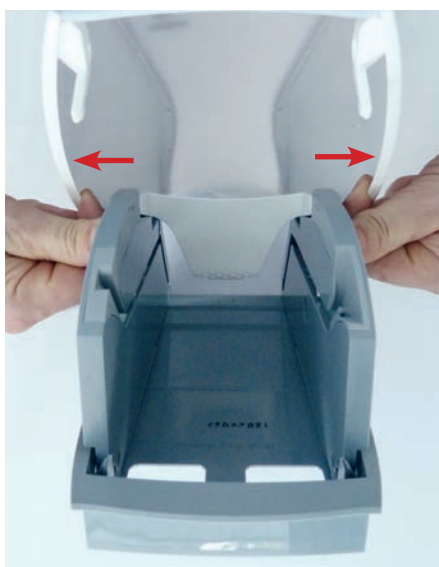

Fig. 5



Fig. 6

rotation point

## Change the lid clip



Fig. 1

### **Change of the lid clip:**

*Twist the lid clip counterclockwise until it strikes and remove it. (Fig. 1 + 2)*

*The insert of the lid happens in the opposite order.*

*Spare part name:  
XIBU WC lid clip*

*Artikel number:  
492011830000*



Fig. 2

**XIBU senseFOAM**

Article no. **411020105000**



Fig. 1

*XIBU senseFOAM Technical package*



Fig. 2

Spare part name:  
*XIBU senseFOAM techn. package*  
Article no. **492011650000**

*XIBU senseDISINFECT Technical package*



Fig. 3

Spare part name:  
*XIBU senseDISINFECT techn. package*  
Article no. **492011820000**

*XIBU senseDISHES Technical package*



Fig. 4

Spare part name:  
*XIBU senseDISHES techn. package*  
Article no. **492011880000**

*Replacing the cover assembly*



Fig. 1: Cover assembly, white

**Tools used:**

Phillips screwdriver size PH1

**Replacing the cover:**

Open the dispenser with the XIBU key

- 1 Loosen the screws on the left and the right side of the cover, (Fig. 2 and 3) so that the cover can be pushed back. (Fig. 3)  
The cover can now be removed.

**XIBU senseDISHES**

Spare part name:  
XIBU senseDISHES cover  
Article no.  
492011895000

**XIBU senseDISINFECT**

Spare part name:  
DI cover white XIBU  
Article no.  
492011645000

**XIBU senseFOAM**

Spare part name:  
SE cover white XIBU  
Article no.  
492011575000

**XIBU touchFOAM**

Spare part name:  
SE cover white XIBU touch  
Article no.  
492011765000

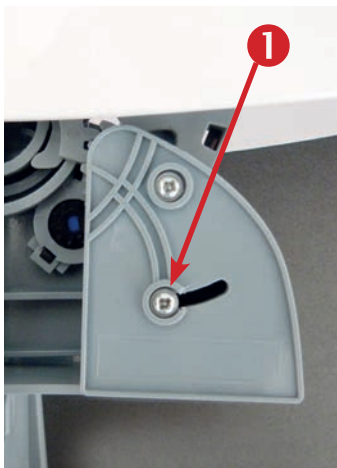

Fig. 2

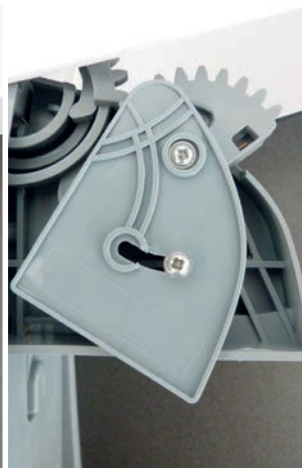

Fig. 3

Slide the new cover into the guide on the swivel joint and put back together in the reverse order.



*Replacing the potentiometer axis*



Fig. 1

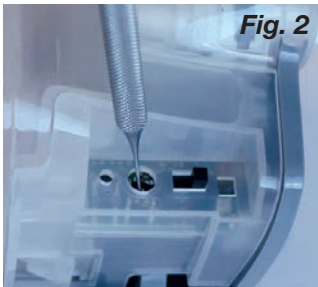

Fig. 2

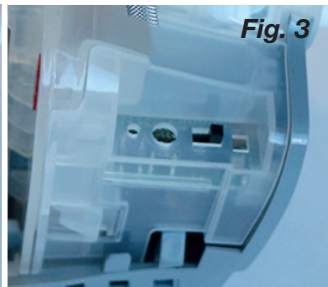

Fig. 3

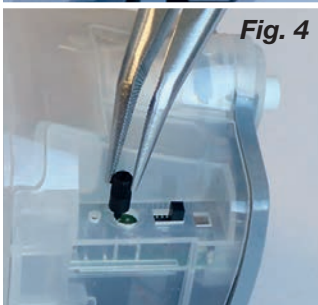

Fig. 4



Fig. 5

**Tools used:**

Pin punch (Fig. 6)  
Needle nose pliers  
XIBU key

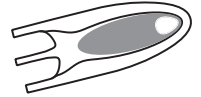

**Requiem:**

Broken potentiometer axis



**Solution:**

Replace the potentiometer axis

Push the remainder of the potentiometer shaft out with the pin punch (Fig. 2)

Insert the new potentiometer shaft (Fig. 3 and 4) with the needle nose pliers and press it in lightly by hand (Fig. 5)

Spare part name:  
SE potentiometer axis XIBU  
Article no. 492011580000



Fig. 6 ▲

**XIBU senseFOAM / XIBU senseDISINFECT / XIBU senseDISHES**

*Battery tray assembly*



Fig. 7: Battery tray assembly

**Request:**

No blinking signal, dispenser without function

**Possible causes:** Batteries are completely empty, the battery springs are broken, the battery contacts are oxidised

**Solution:**

Replace the batteries and/or battery tray

Spare part name: SE battery case XIBU  
Article no. 492011590000

*Changing the soap/disinfect tank*



*Spare part name:  
XIBU SE-S Tank komplett HAG  
Article no.: 492012000000*

*Spare part name:  
XIBU DIS Tank komplett HAG  
Article no: 492012010000*

**Request:**

*intake bag broken  
fill level display does not work  
third party product was filled in  
technical package has to be replaced*



Fig. 1

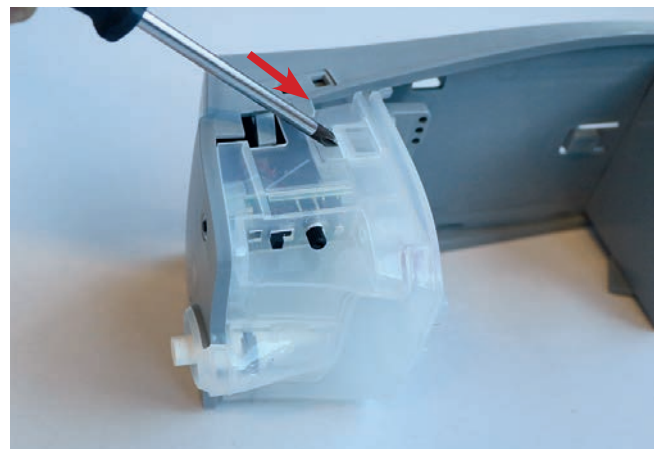

Fig. 2

**Solution:**

*replace the tank*

*Remove the dispenser from the wall and turn it around.*

*Press in the notches with the screwdriver, and pull out the tank (Fig. 1-2).*

*Insert the new soap tank and press in until the tank snaps into place (click).*

## XIBU senseSEATCLEANER / XIBU senseMOISTCARE



### XIBU senseSEATCLEANER

Article no.:  
**411010145000**



### XIBU senseMOISTCARE

Article no.:  
**411010165000**



### Technical package

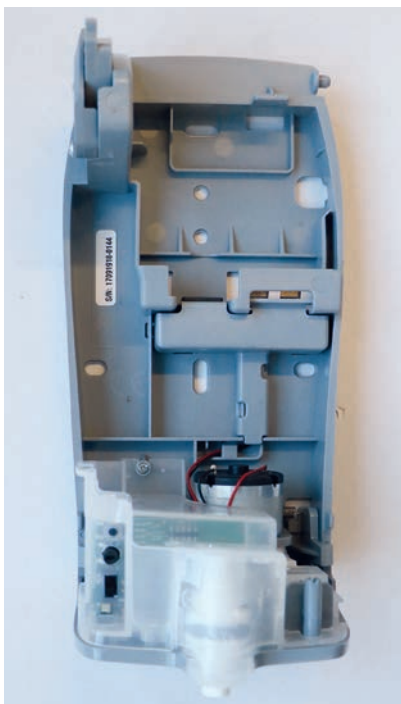

Spare part name:  
**XIBU senseSEATCLEANER TP**

Article no.:  
**492012110000**



Spare part name:  
**XIBU MOISTCARE TP**

Article no.:  
**492012130000**

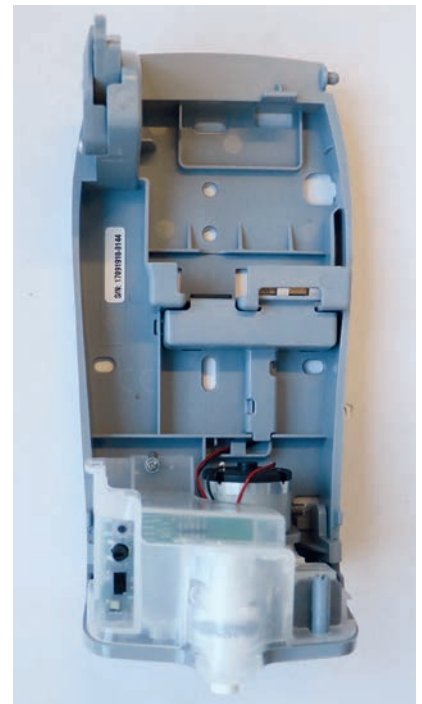

Fig. 1: senseSEATCLEANER technology package

Fig. 2: senseMOISTCARE technology package

*Replacing the cover assembly*



Fig. 1  
XIBU senseSEATCLEANER lid



Fig. 2  
XIBU touchSEATCLEANER lid



Fig. 3  
XIBU senseMOISTCARE lid

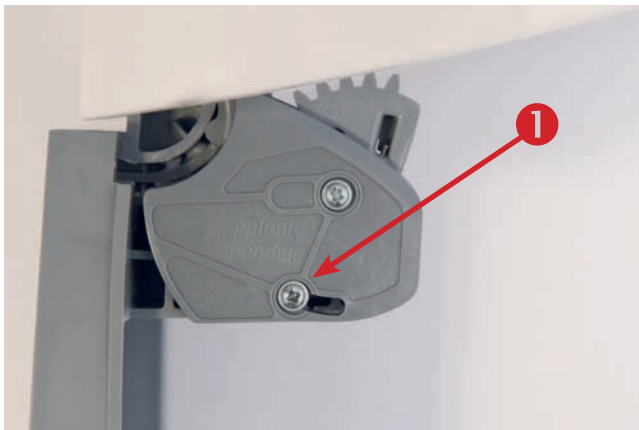

Fig. 4



Fig. 5

**Tools used:**

Phillips screwdriver size PH1

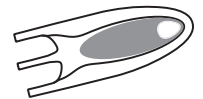

**Lid replacement:**

Open the dispenser with the XIBU key.

**Undo screw 1** on the left-hand side of the cover (Figs. 4 and 5) so that the covers can be pushed to the back (Fig. 5). The lid can now be taken off.

Insert the new lid into the guide at the pivot joint and reassemble in reverse order.

## XIBU touchFOAM



### *XIBU touchFOAM w/*

Article no.  
**411020145000**

### *Technical package*



Fig. 1: touchFOAM technical package

Spare part name:  
*XIBU touchFOAM white techn.p.*

Article no.  
**492011740000**

---

Spare part name:  
*XIBU touchFOAM black techn.p.*

Article no.  
**492011750000**

## Replacing the technical package assembly



Fig. 1

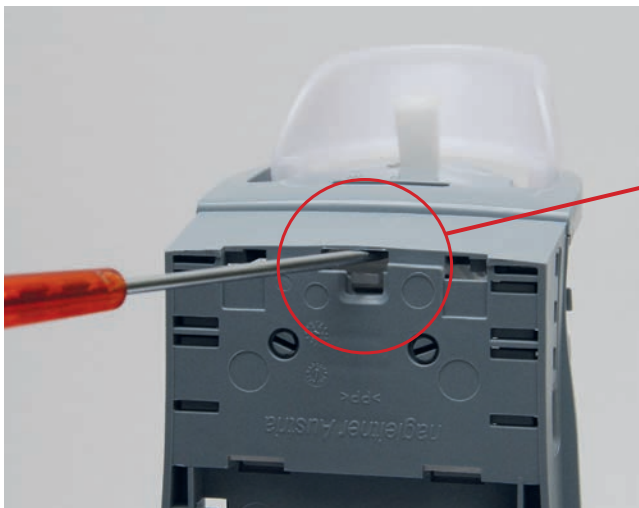

Fig. 2

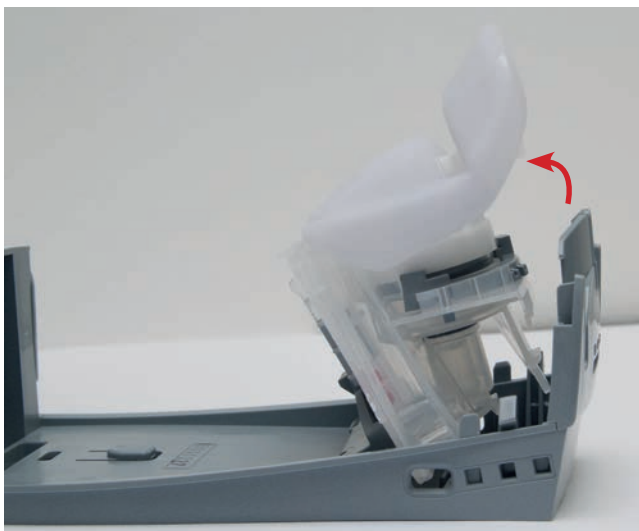
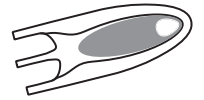

Fig. 3

### Tools used:

Slot screwdriver, size 2  
XIBU key



### Replacing the technical package:

Loosen the push piece from both latches.  
(Fig. 1)

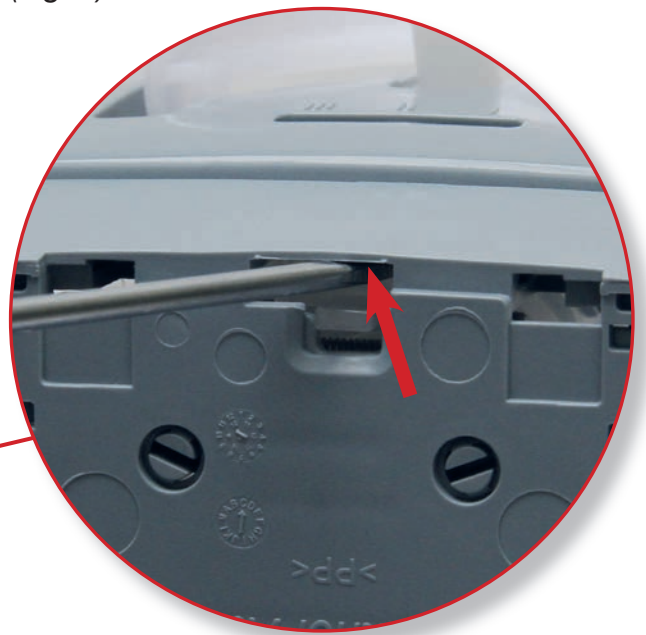

Loosen the lock on the bottom of the rear side by using the screwdriver.  
(Fig. 2)

Pull the technical package forwards (Fig. 3) and loosen it from the holder.

The installation of the new technical package takes place in the reverse order.

## XIBU touchSEATCLEANER



### **XIBU touchSEATCLEANER**

Article no.:

**411010155000**

### *Technical package*



Fig. 1: touchSEATCLEANER TP dl

Spare part name:  
*XIBU touchSEATCLEANER TP bl*

Article no.: 492012105000

Spare part name:  
*XIBU touchSEATCLEANER TP dl*

Article no.: 492012106700

# XIBU touchSEATCLEANER

## Replacing the technical package assembly



Fig. 1

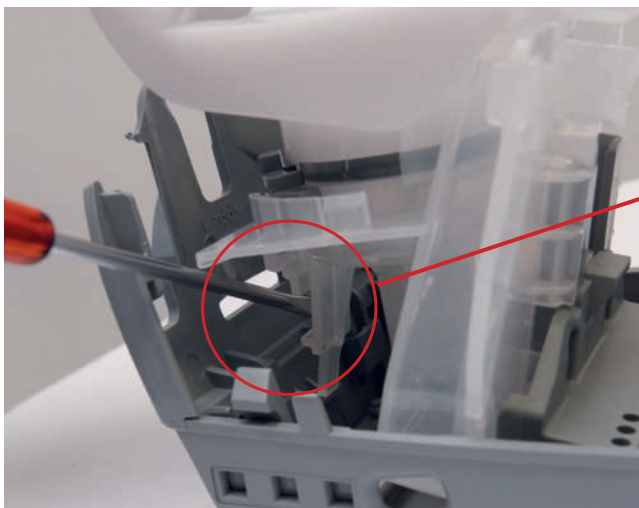

Fig. 2

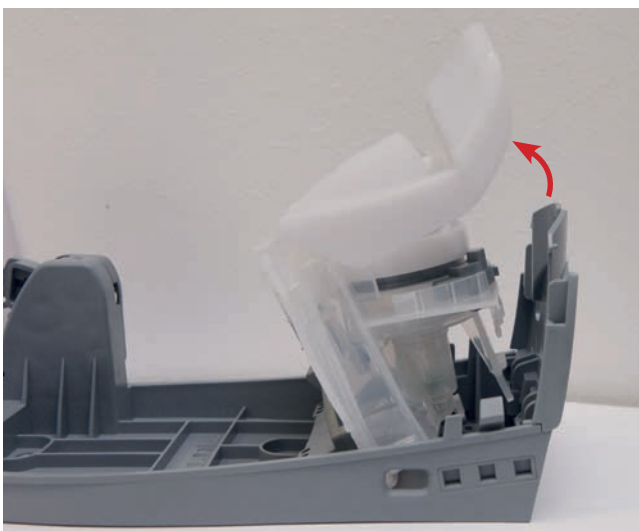
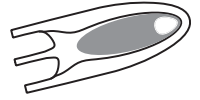

Fig.3

### Tools used:

Slot screwdriver, size 2  
XIBU key



### Replacing the technical package:

Loosen the push piece from both latches.  
(Fig. 1)

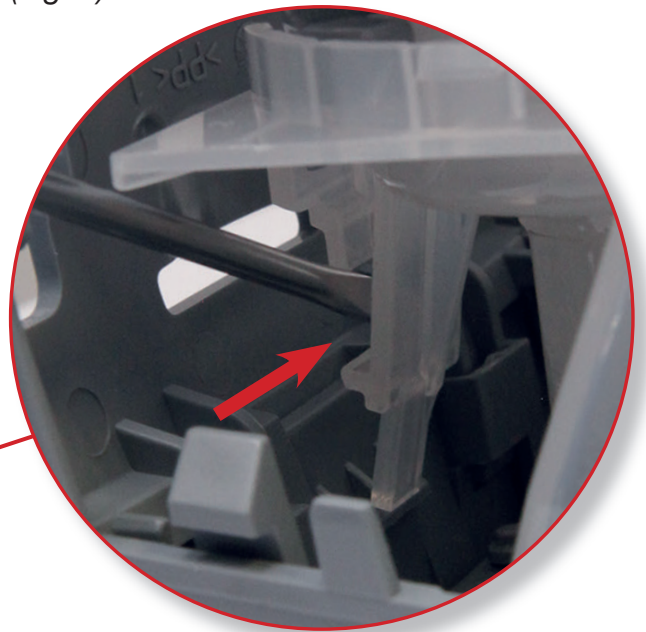

Open the lock at the bottom using a screwdriver (Fig. 2).

Pull the technology package forward (Fig. 3) and detach it from the mounting.

Install the new technology package by following above instructions in reverse order.



## XIBU senseTOWEL



### XIBU senseTOWEL

Article no.  
411020115000

Fig. 1: XIBU senseTOWEL

## Technical package

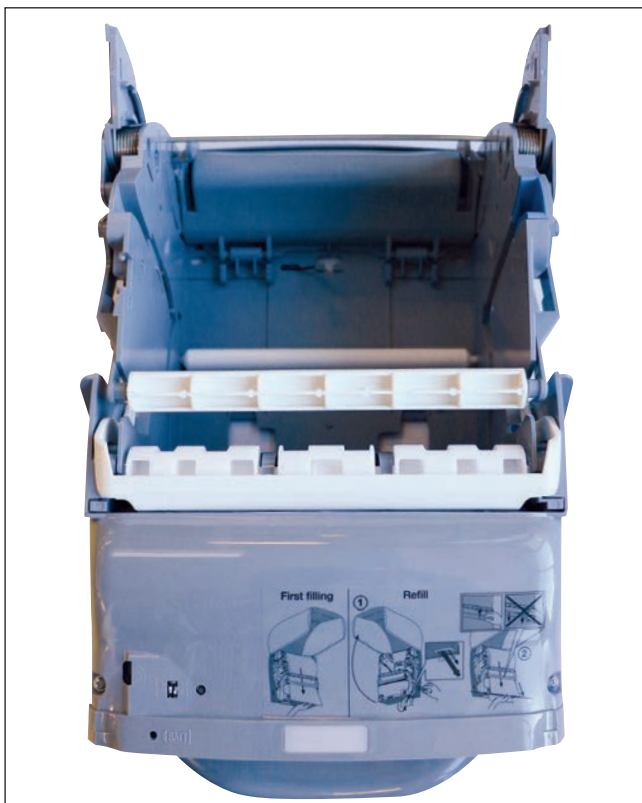

**Spare part compatible with batch  
no. 110115XX and higher**

Fig. 2: XIBU senseTOWEL Technical package

**Spare part name:**  
XIBU senseTOWEL techn. package

Article no.  
492011660000

## Replacing the cover assembly

### Tools used:

Phillips screwdriver size PH1  
XIBU key

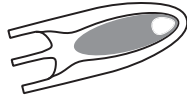

Fig. 1: Baugruppe Deckel weiß

### REPLACING THE COVER

Use the XIBU key to  
Open the cover → remove the paper roll →

Remove screw **2** on the left and the right  
side of the cover swivel joint using the Phillips  
screwdriver. (Fig. 2 and 3)

Loosen screw **1** by a single rotation.  
**Attention! Only a single rotation**  
(Fig. 2 and 3)

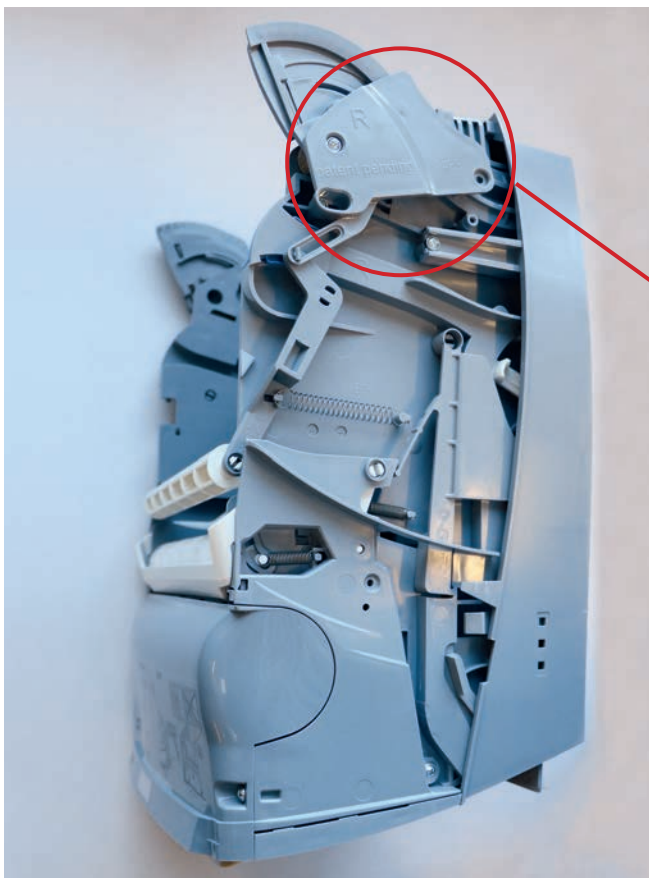

Fig. 2



Fig. 3

## Replacing the cover assembly



Fig. 1

*Twist the swivel joint upwards to the right and left as seen in Fig. 1.*

*This exposes the gears of the cover and the cover can be carefully lifted out.*

*When mounting the cover, ensure that the guides slide inside each other (Fig. 3) and the gears are positioned as in (Fig. 2).*



Fig. 2



Fig. 3



Fig. 4

*Then twist the cover swivel joint back to its original position and tighten both screws again (Fig. 4)*

**Spare part name:**  
HT cover white XIBU

**Article no.**  
492011525000

## Cover microswitch



Fig. 1

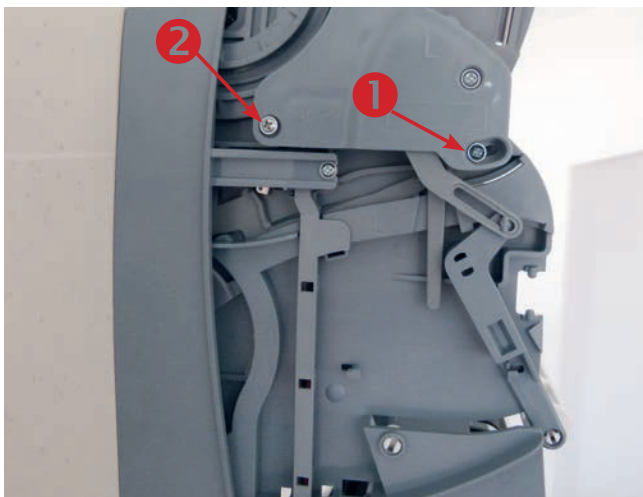

Fig. 2



Fig. 3

### **Tools used:**

Phillips screwdriver size PH1

Long nose pliers

### **Request:**

No paper is dispensed despite a green blinking LED (no difference whether the cover is open or closed).

### **Possible cause:**

Microswitch (cover) is not working!

### **Analysis:**

Press and hold the microswitch with a finger (Fig. 1) now check whether the dispenser is dispensing paper?

The dispenser is dispensing paper!

### **Solution:**

On the cover swivel joint, remove **screw 2** on the left and loosen **screw 1** (1 rotation).

Rotate the cover upwards so that the microswitch becomes visible (Fig. 2).

Now gently bend the microswitch upwards using the long nose pliers (Fig. 3 and 4).

It is put back together in the reverse order.

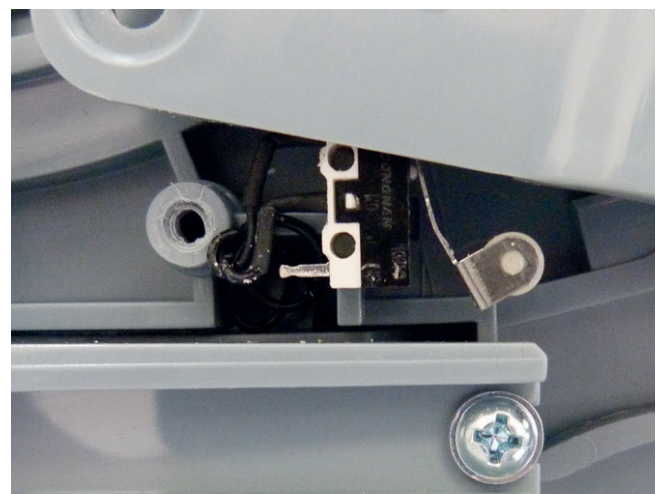

Fig. 4

## Replacing the battery tray

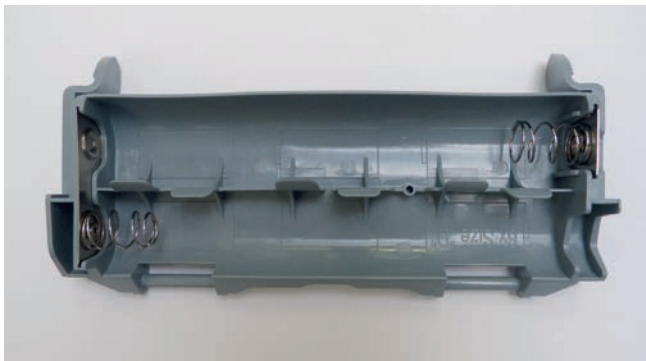

Fig. 1: battery tray



Fig. 2



Fig. 3



Fig. 5

### **Request:**

No blinking signal and/or no function!

### **Possible causes:**

The batteries are completely empty  
the battery springs are broken  
the battery contacts are oxidised

### **Solution:**

Replace the batteries and/or battery tray

Open the cover → remove the paper roll →

Open the battery tray by pressing in the 2 tabs of the battery tray (see the arrow on the battery tray)  
(Fig. 2 – 3)

After removing the batteries, press in on the tabs again and push the battery tray all the way down. (Fig. 4)



Fig. 4

Remove the batteries from the holder and replace them (Fig. 5)

The installation of the battery tray takes place in the reverse order.

Spare part name:  
BG HT battery case XIBU

Article no.  
492011530000

## Tensioning roller spring



Fig. 1 roller spring

### Tools used:

XIBU key

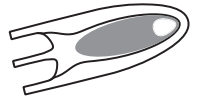

### Request:

Paper comes out of the dispenser crooked (comes out one-sided).

### Solution:

Replace the tensioning roller spring (missing)

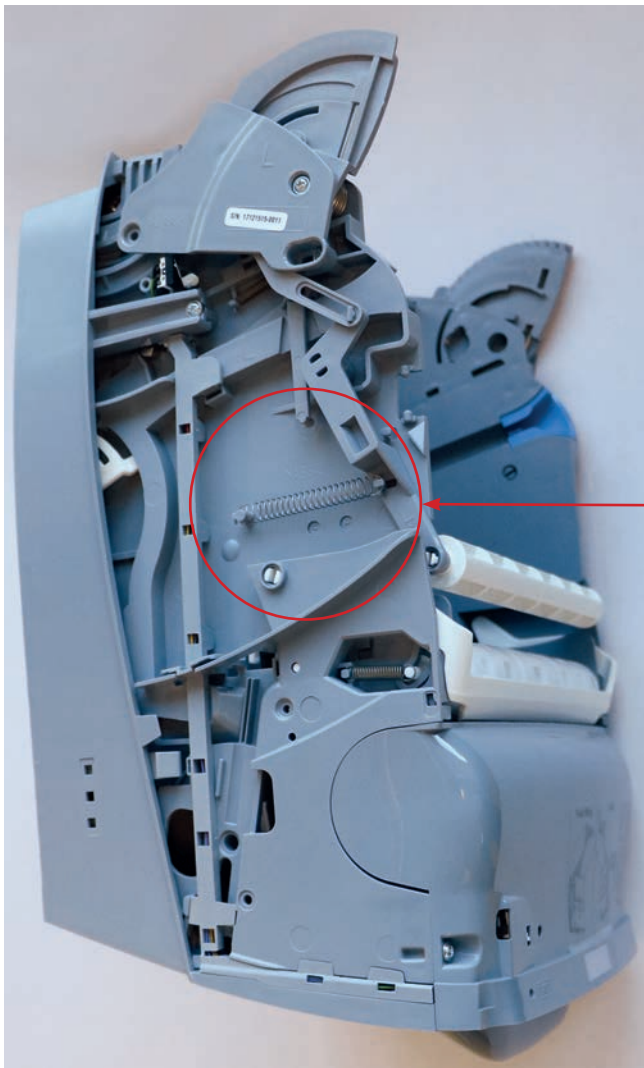

Fig. 2

Open the cover → hook in the spring left and/or right (Fig. 2 and 3).



Fig. 3

Spare part name:  
XIBU HTR tension.roller.spring

Article no.  
492011680000

## Replacing the cutting unit assembly

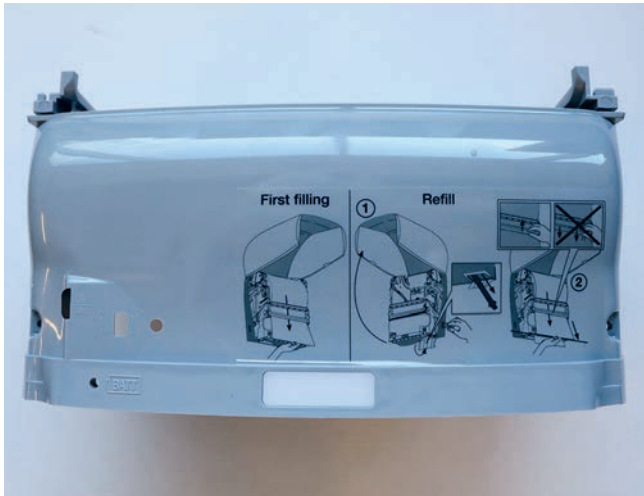

Fig. 1: cutting unit

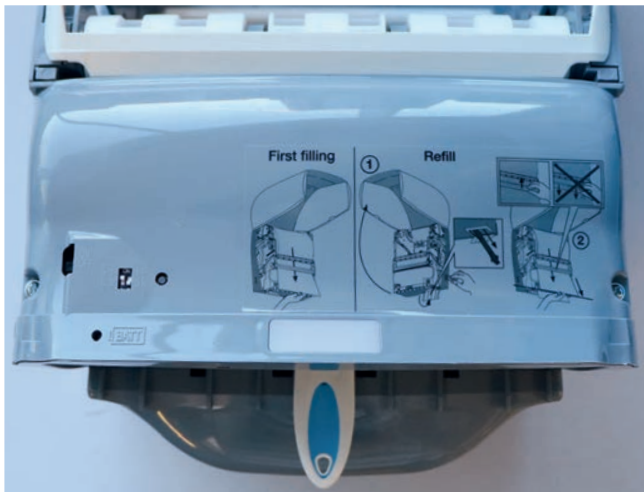

Fig. 2

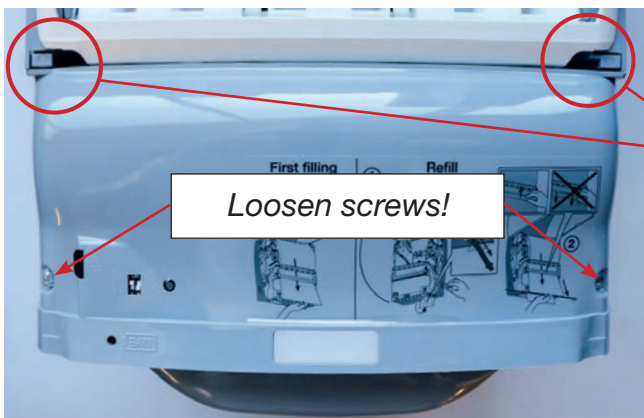

Fig. 3

### Tools used:

Phillips screwdriver, size PH1  
slot screwdriver, size 2

### Request:

Paper jam; paper is cut poorly or not at all.

### Solution:

Replace the cutting unit.

Open the cover → remove the paper roll → press the hand button back and insert the XIBU key (Fig. 2). Loosen both screws on the cutting unit (Fig. 3)

Press down the catches on the left and the right side with a slot screwdriver to loosen the cutting unit. (Fig. 4)

**Spare part compatible with batch no. 110115XX and higher**

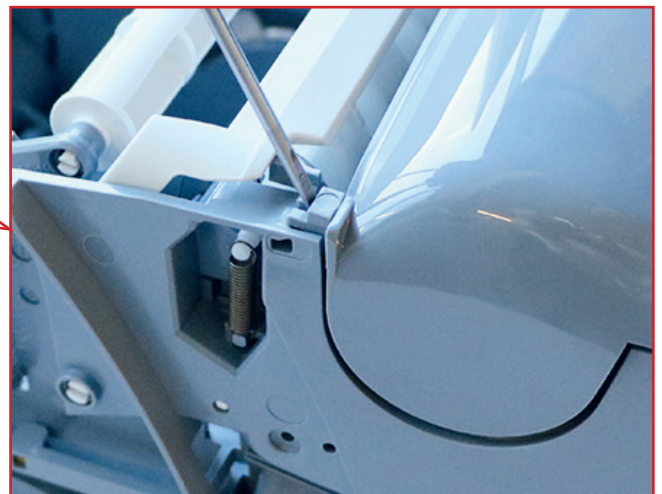

Fig. 4

## Replacing the cutting unit assembly

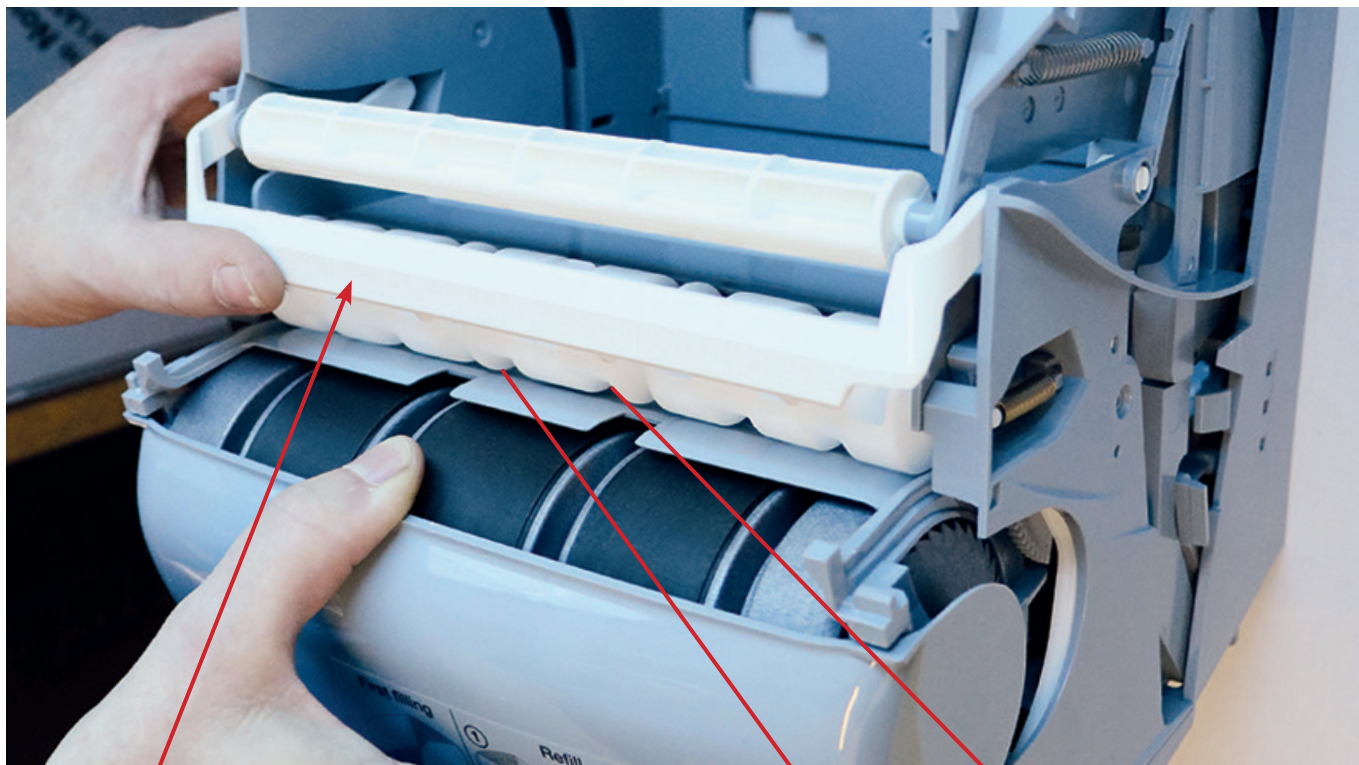
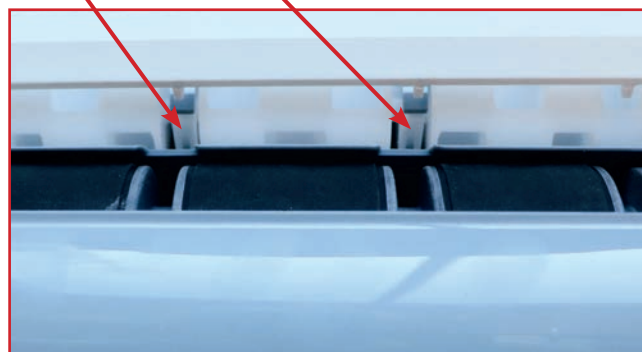

Fig. 1

Lift the paper sensor lever and tilt the cutting unit forward and/or remove it. (Fig. 1 and 2)



**Please observe:**

On installation, the paper sensor must slide over the cutting unit!

**Installation of the new cutting unit:**

Lift the paper sensor lever slightly and carefully push in the cutting unit.

Tighten the 2 screws again and remove the XIBU key from its anchoring position.

Replace the paper roll, turn the switch to „on“ and close the cover →

**Test the dispenser!**

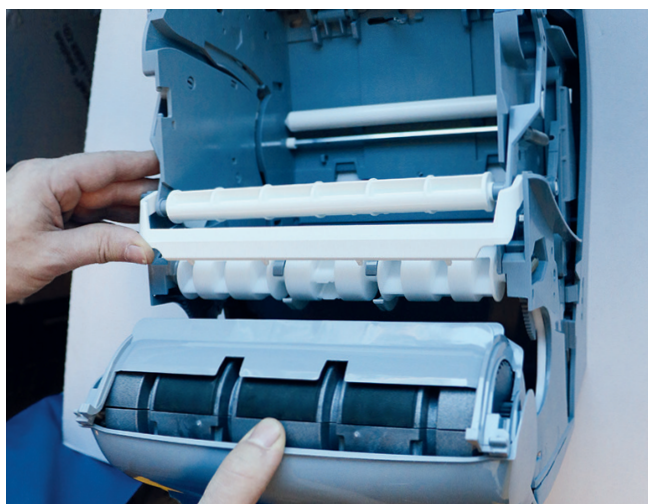

Fig. 2

Spare part name:  
BG. HT cutting unit XIBU w.  
Article no. 492011540000



# XIBU senseTOWEL

## Replacing the lower counter roller

### Tools used:

Phillips screwdriver size PH1



### Request:

Paper is not transported.

Motor noises can be heard (at rest)

Irregular feeding sound. Rubber has completely or partially come off the drive roller

### Solution:

Replace the lower counter roller.

Open the dispenser, open the battery tray

Remove the cutting unit →

The lower counter roller is now visible (Fig. 1).

**Spare part compatible with batch no. 110115XX and higher**

Spare part name:  
XIBU senseTOWEL counter roller

Article no.  
492011690000



Fig. 2: XIBU senseTOWEL lower counter roller

Spare part name:  
Axle clamp ring senseTOWEL

Article no.: 492012280000



Remove the axle clamp ring from the axle by using a screw driver (Fig. 1).

Move the counter roll off the right and the left side of the holder. (Fig. 2 and 3)

Pull the panel toward you - it provides enough space to unthread and to remove the counter roll. (Fig. 4 and 5)

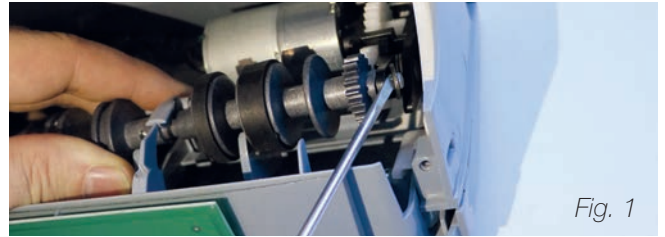

Fig. 1

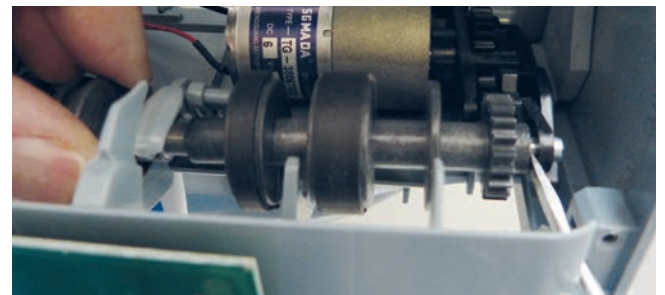

Fig. 2

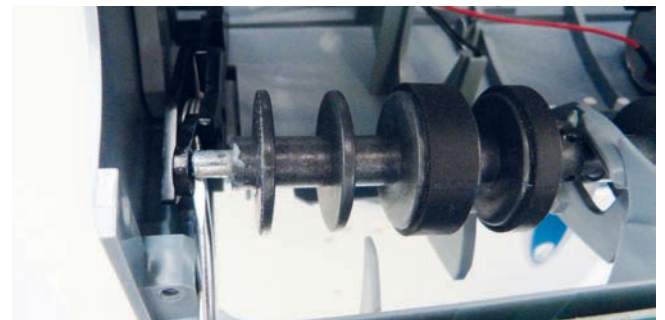

Fig. 3

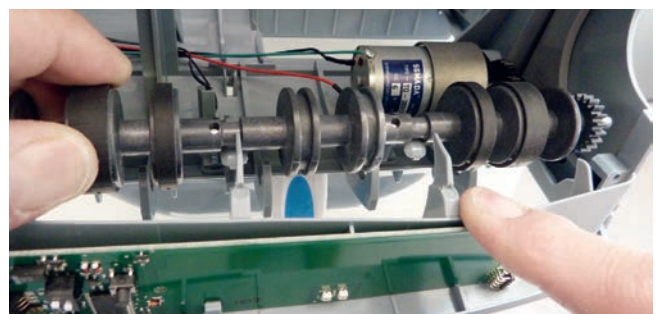

Fig. 4

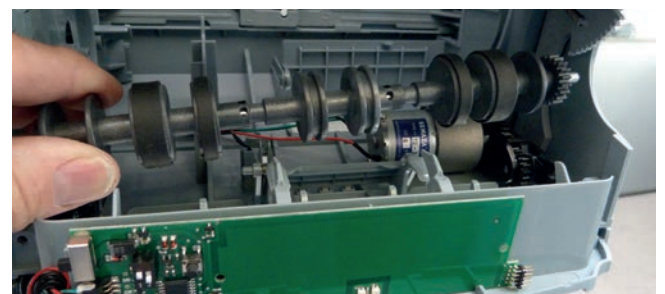
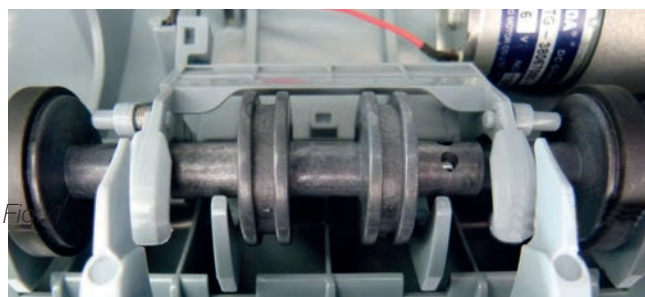
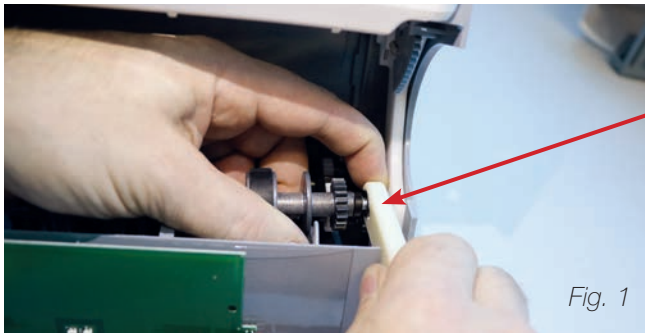

Fig. 5

## Replacing the lower counter roller



The installation takes place in reverse order. Insert a new axle clamp ring onto the axle with the help of the mounting finger (Fig. 1 + 2).

After the counter roller has been installed, the rocker has to be checked for ease movement and correct positioning. (Fig. 3)

## ESD Film installation

Spare part name: XIBU HTR ESD Film

Article no: 492012120000

### Request:

Dispenser automatically dispenses paper or dispenses paper.

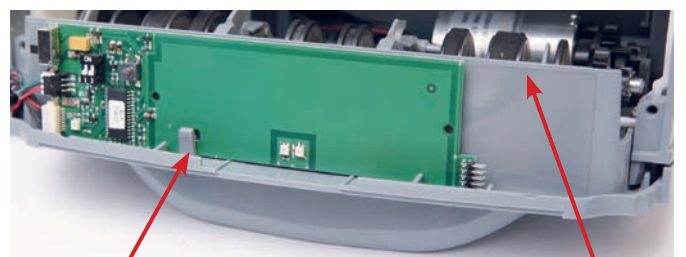
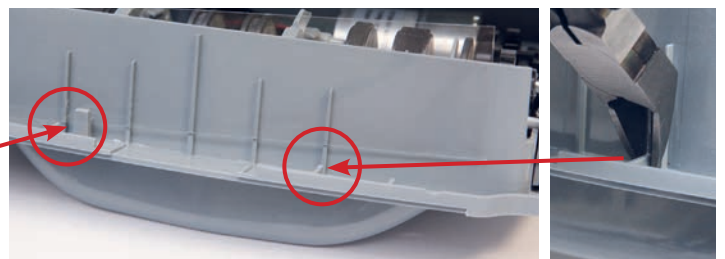
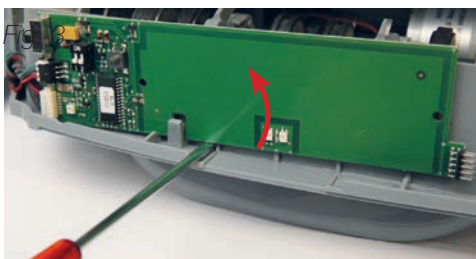

Film must not protrude

## XIBU senseTOWEL/touchTOWEL

### Replacing the top counter roller

**This error appear only with dispensers showing a batch.-no. before 141027XX.**

#### **Tool used:**

Flat screw driver

#### **Issue:**

Paper is cut poorly or on one side only

#### **Solution:**

Replace top counter roller when broken.

Remove central reinforcement. For this purpose, lever out the latch mechanism on the left and right-hand sides by means of a flat screwdriver, (Fig. 1) and remove the central reinforcement upwards and out of the dispenser (Figs. 2+3). Push tension roller to the front.

Remove both springs on the counter roller (Fig. 4).

Remove defective counter roller (Fig. 5).



Fig. 1



Fig. 4



Fig. 2



Fig. 3

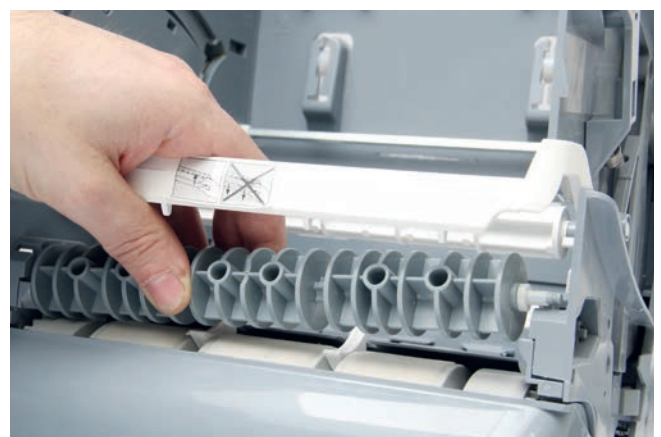

Fig. 5

Name of spare part:  
Top counter roller 1K

Article number:  
4920119900

## Replacing the top counter roller

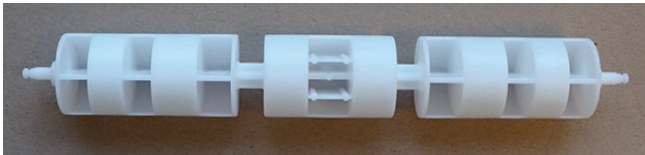

Fig. 1

Insert spare part (Fig. 1) – hook in both springs again.

Re-insert central reinforcement from above. Please make sure that the component is inserted into the vertical guide slots (Fig. 2).

Press down the central reinforcement until it audibly clicks into place and fits accurately and gap-free (Fig. 4).

The distance between the tension roller and central reinforcement must be identical on both sides. The tension roller must not touch the central reinforcement.



Fig. 2

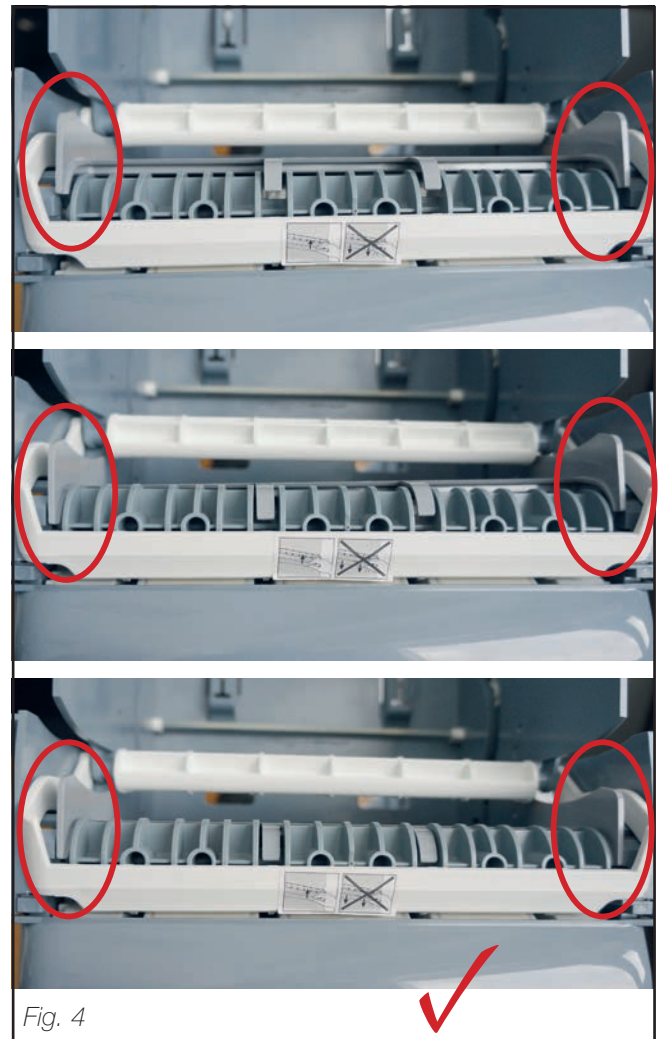

Fig. 4



Fig. 3

## XIBU touchTOWEL



### XIBU touchTOWEL

Article no.  
411020125000

Fig. 1: XIBU touchTOWEL

## Technical package

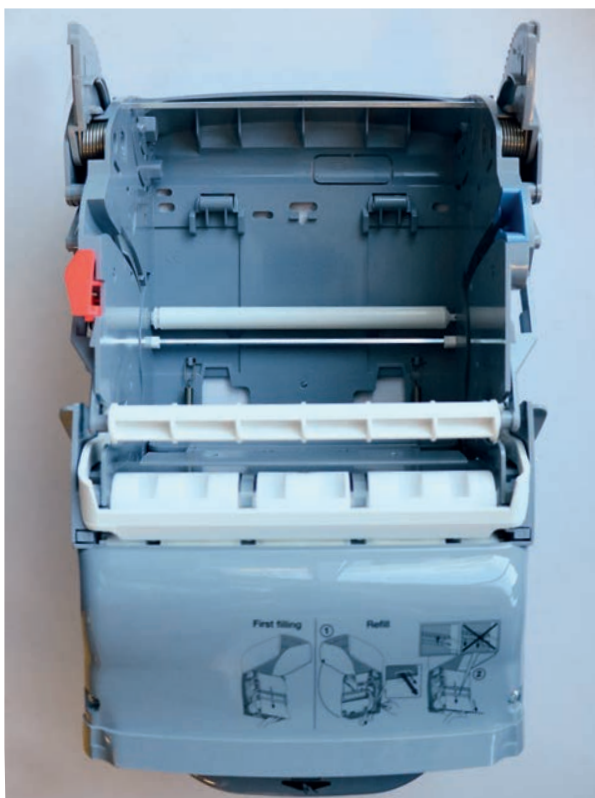

Fig. 2: XIBU touchTOWEL Technical package

Spare part name:  
XIBU touchTOWEL techn.package

Article no.  
492011700000

## Replacing the cover assembly



Fig. 1: Baugruppe Deckel white

### Tools used:

Phillips screwdriver size PH1  
XIBU key

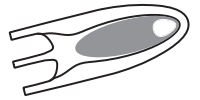

### Replacing the cover

Use the XIBU key to  
Open the cover → remove the paper roll →

Remove screw **2** on the left and the right  
side of the cover swivel joint using the Phillips  
screwdriver. (Fig. 2 and 3)

Loosen screw **1** by a single rotation.  
**Attention! Only a single rotation**  
(Fig. 2 and 3)

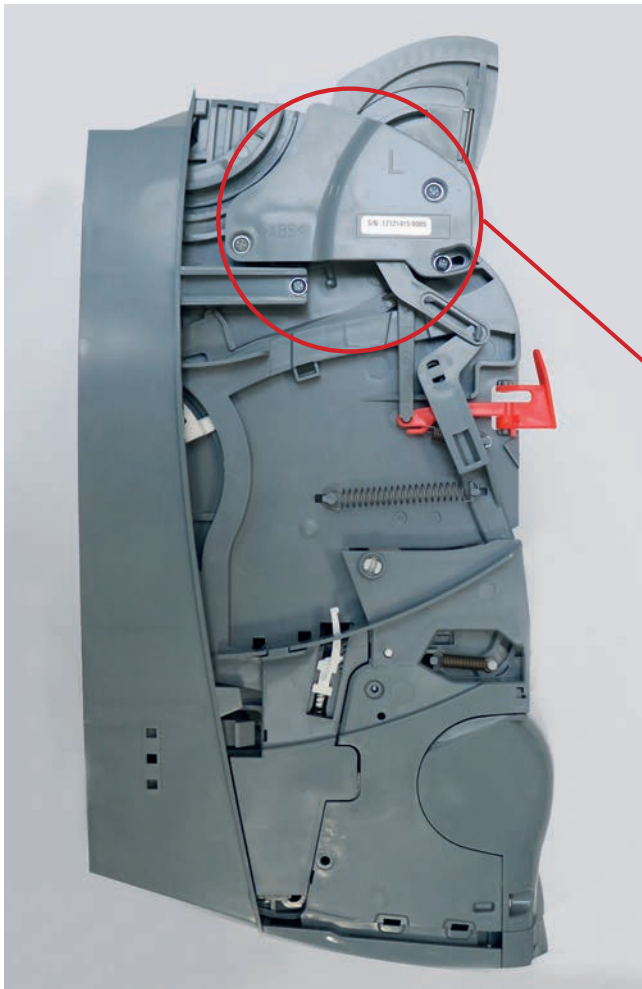

Fig. 2

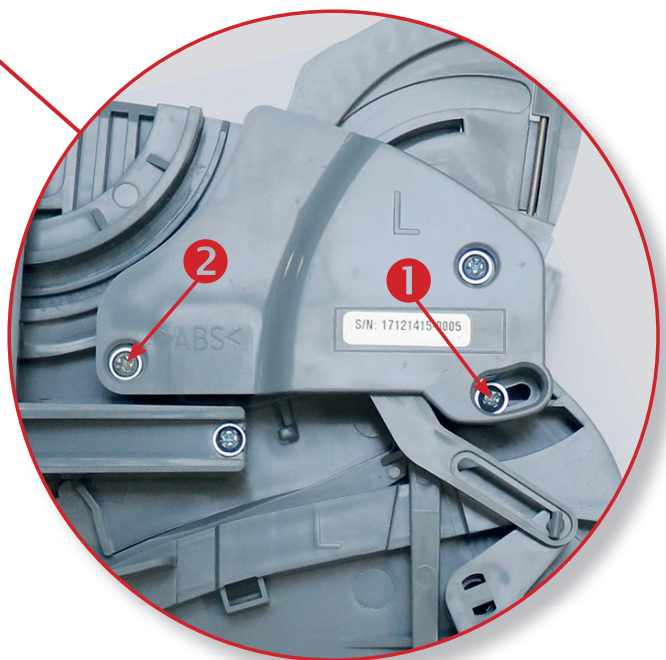

Fig. 3

## Replacing the cover assembly



Fig. 1

*Twist the cover of the swivel joint upwards to the right and left as seen in Fig. 1.*

*This exposes the gears of the cover and the cover can be carefully lifted out.*

*When mounting the cover, ensure that the guides slide inside each other (Fig. 3) and the gears are positioned as in Fig. 2.*



Fig. 2



Fig. 3



Fig. 4

*Then twist the cover of the swivel joint back to its original position and tighten both screws again (Fig. 4)*

*Spare part name:  
HT cover white XIBU touch*

*Article no.  
492011715000*

## Tensioning roller spring



Fig. 1 roller spring

### Tools used:

XIBU key

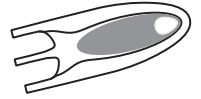

### Request:

Paper comes out of the dispenser crooked (comes out one-sided).

### Solution:

Replace the tensioning roller spring (missing).

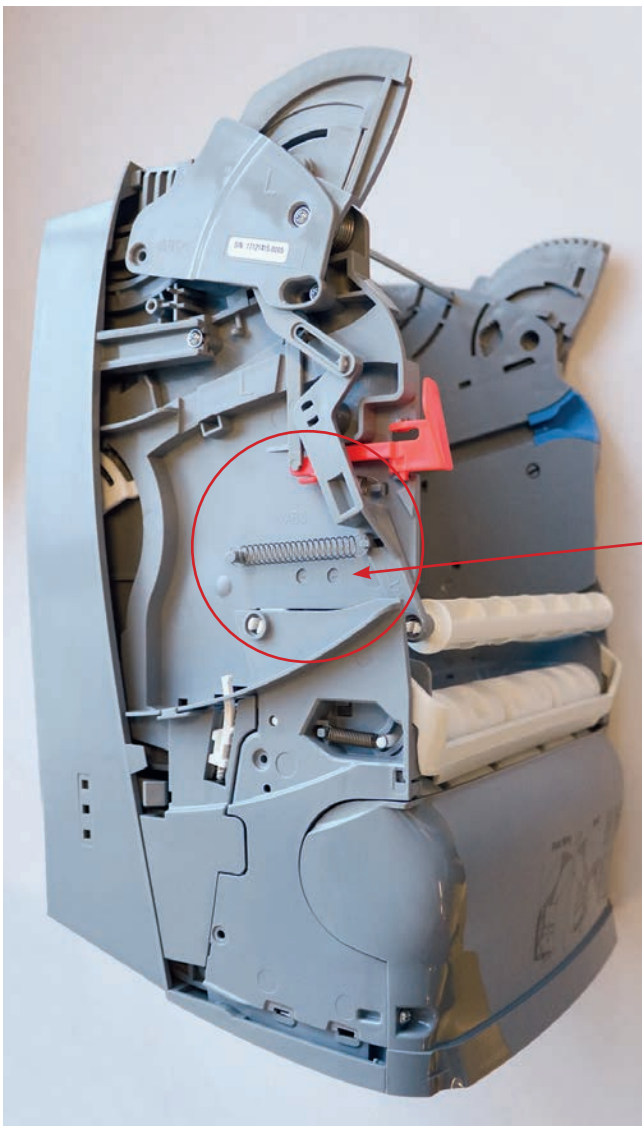

Fig. 2

Open the cover → hook the spring left and/or right (Fig. 1 and 2).

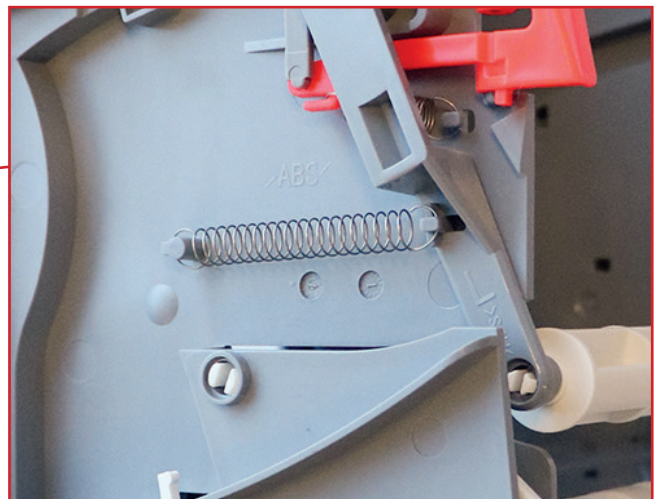

Fig. 3

Spare part name:  
XIBU HTR tension.roller.spring

Article no.  
492011680000



*Insert spring*



Fig. 1

**Request:**

No paper is transported.

**Solution:**

Insert the spring at the mounting points (see Fig. 2).

**Spare part compatible from batch no. Ch.-No. 150113XX**

Spare part name:

XIBU HTR-T Spring Nachförderer

Artikel number:

492011840000

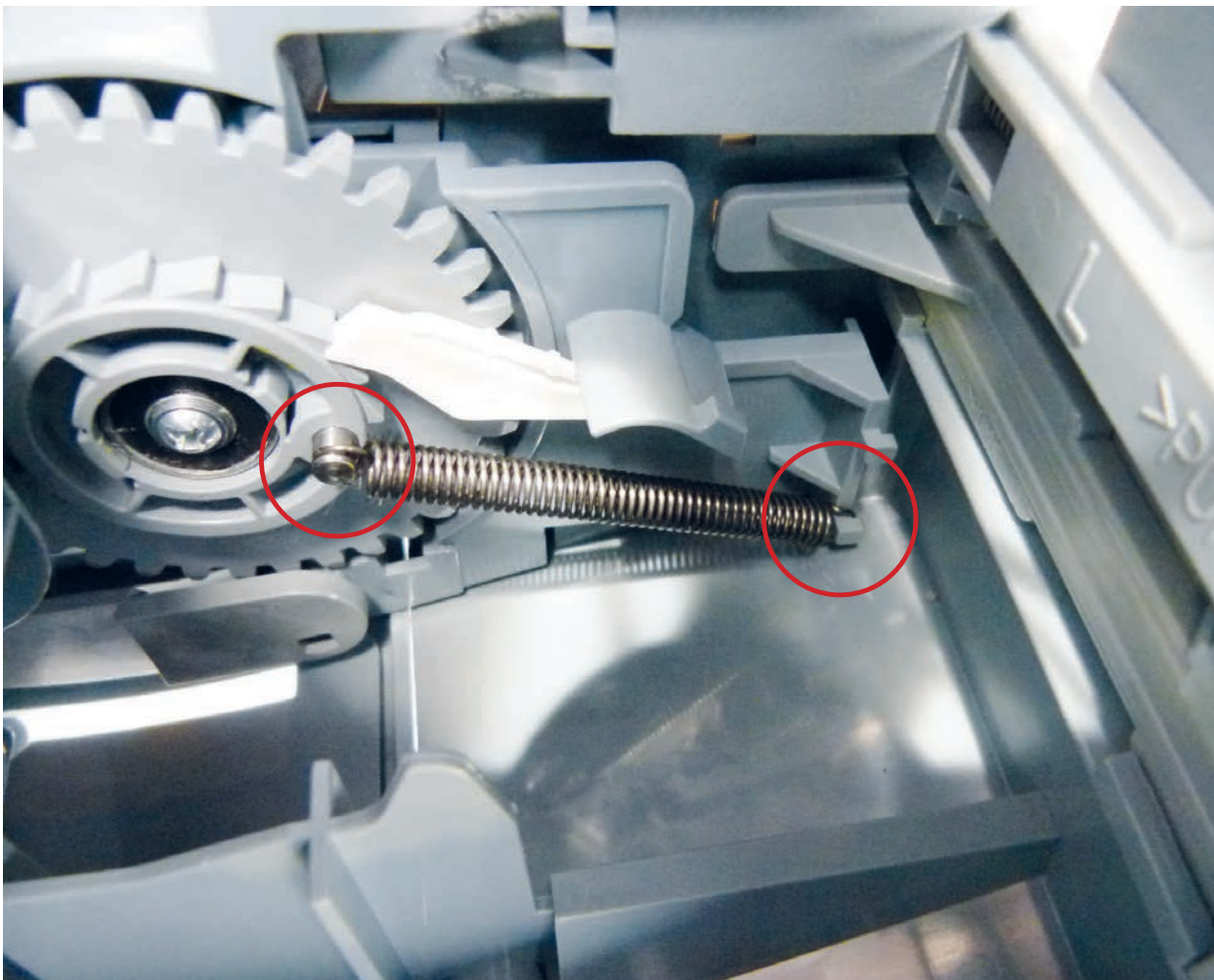

Fig. 2

## Replacing the cutting unit assembly

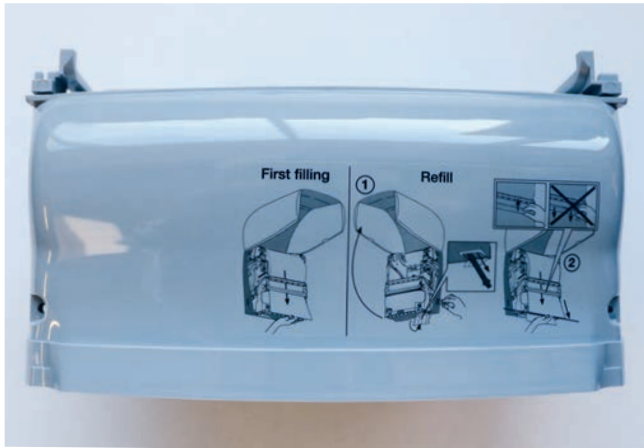

Fig. 1: cutting unit

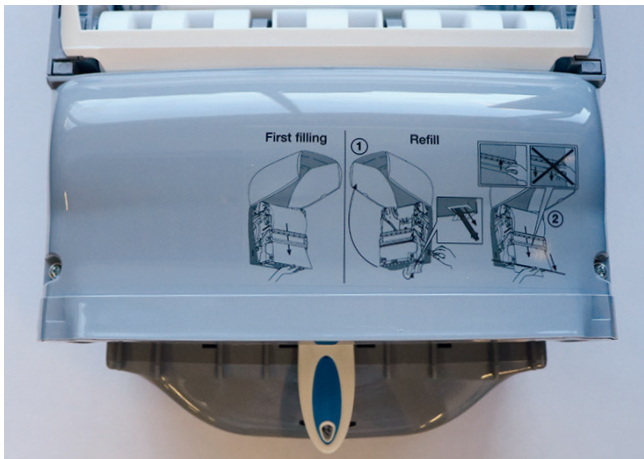

Fig. 2

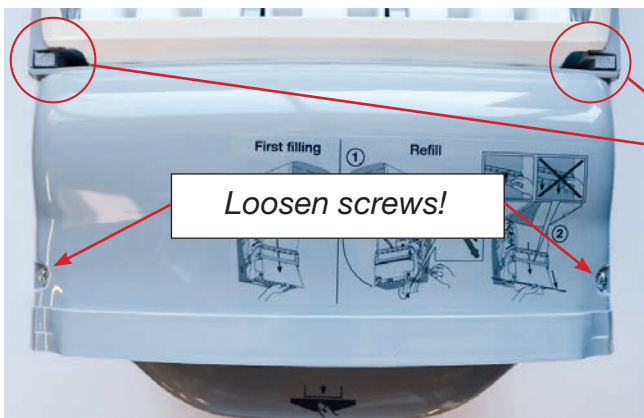

Fig. 3

### Tools used:

Phillips screwdriver, size PH1  
slot screwdriver, size 2

### Problem:

Paper jam; paper is cut badly or not at all.

### Solution:

Clean the cutting unit, remove paper residues from the cutting unit or between the gears.

Open lid → Remove paper roll → Press the hand button back and insert the XIBU key (Fig. 2). Undo the two screws at the cutting unit (Fig. 3).

Push down the latches at the left and right with a flat-tip screwdriver to remove the cutting unit (Fig. 4).



Fig. 4

## Replacing the cutting unit assembly

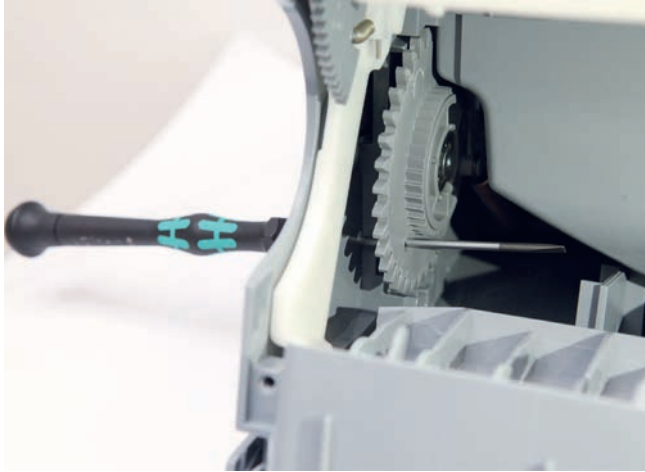

Fig. 1

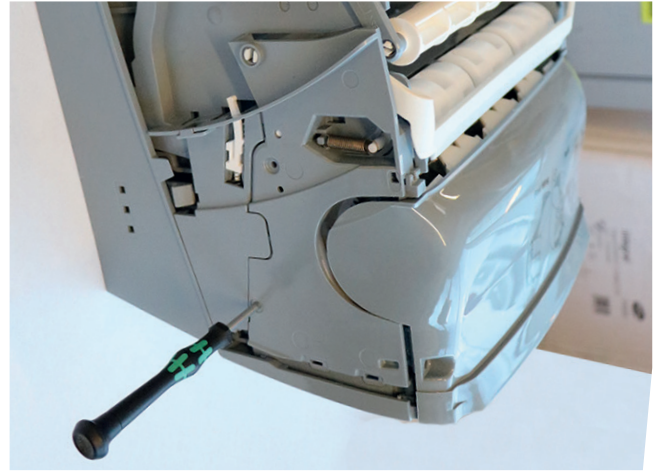

Fig. 2

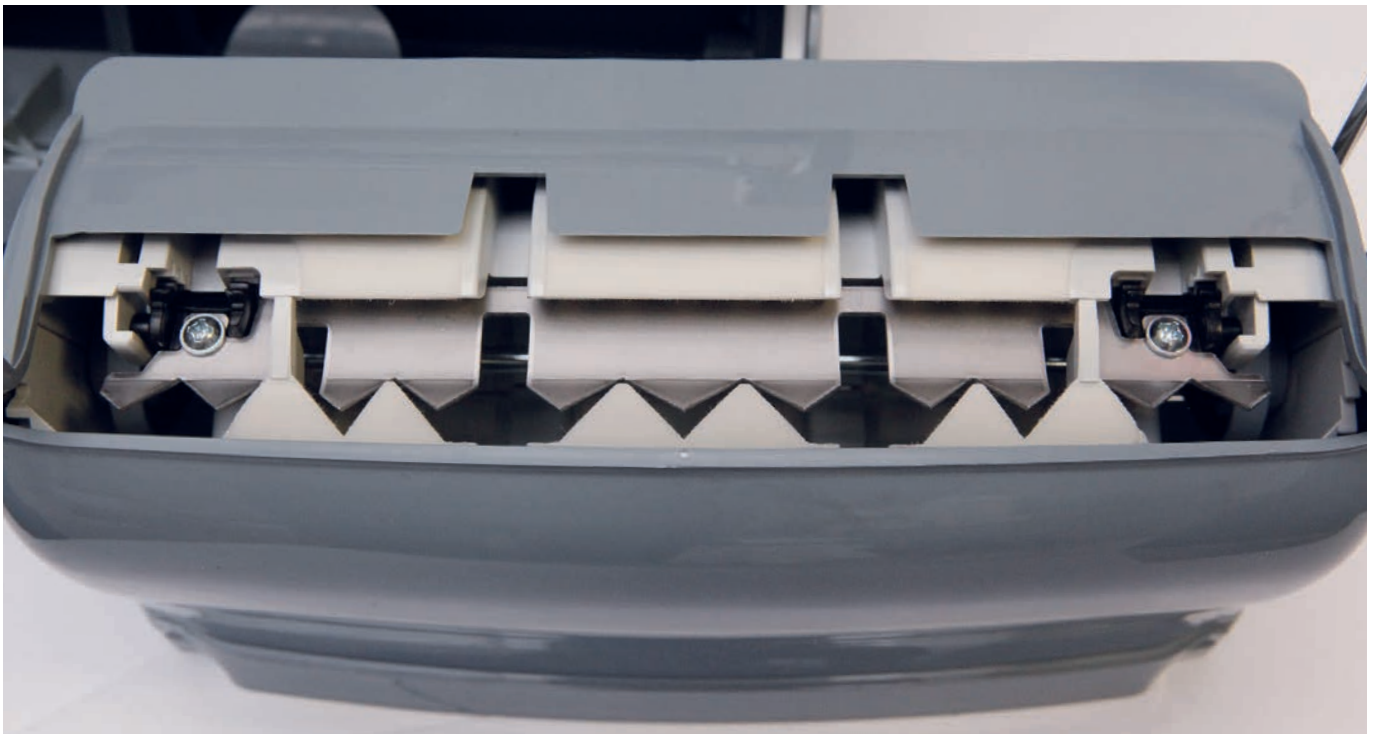

Fig. 3

Setting the position of the supply cogwheel using a screwdriver (Fig. 1 + Fig. 2).

Bring the blade of the cutting unit into exactly the same position as shown in Fig. 3.

**Careful!**

**The position of the blade must not be changed when putting the cutting unit back in!**

Fasten the cutting unit again with both screws.

## Exchange the spring time interval

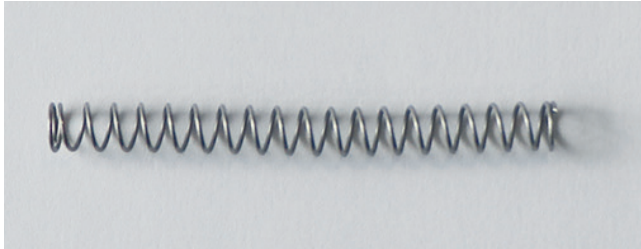
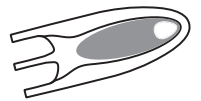

Fig. 1

Spare part name:  
XIBU HTR-T D-Feder Zeitverz.

Article no.:  
492012140000

**Tools used:**  
XIBU key



**Request:**  
Time delay is too short or too long.

**Solution:**  
Change the spring time interval.

Open the dispenser → press handle time interval and remove upwards (Fig. 2).

Remove the spring and replace it with the new spring time interval (Fig. 3).

Replace the handle and engage in the 1st position (at the very bottom) (Fig. 4).

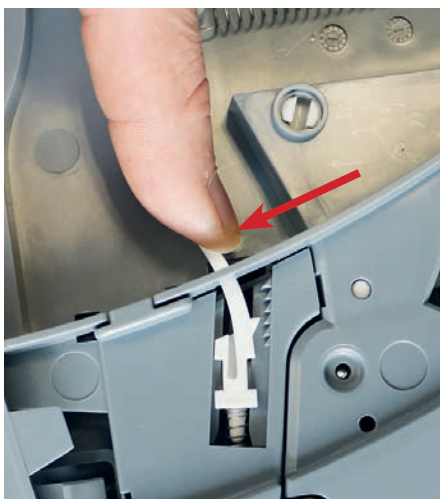

Fig. 2



Fig. 3

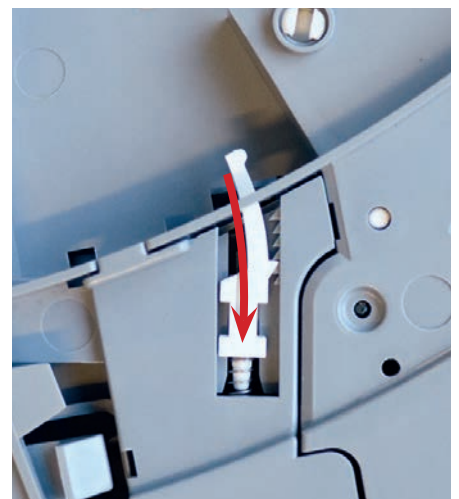

Fig. 4



## XIBU senseFRESHAIR

Article no.  
411020135000

Fig. 1 XIBU senseFRESHAIR

### Replacing the AF adjustment pin



Fig. 2

#### Tools used:

Pin punch (Fig. 2)  
Needle nose pliers, XIBU key

#### Request:

The adjustment pin is broken



#### Solution:

Replace the adjustment pin



Fig. 3

Push out the remainder of the adjustment pin by using the pin punch (Fig. 3)  
Insert the new adjustment pin halfway and turn it completely to the left. Take the adjustment pin out again using the needle nose pliers and then press it in again until it locks into position. (Arrow mark on the left side)

Spare part name: AF adjusting pin  
Article no. 492011080000

## Replacing the technical package assembly

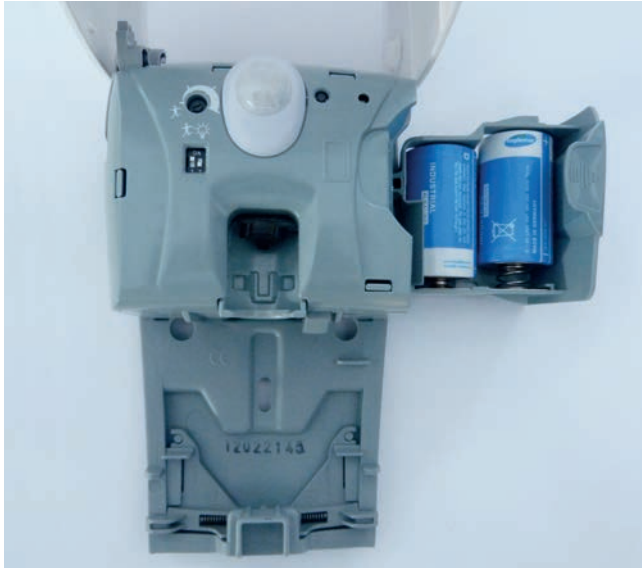
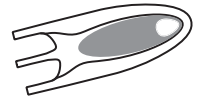

Fig. 1

### Tools used:

XIBU key



Open the dispenser with the XIBU key. Remove the battery tray from the technical package. (Fig. 1)

Remove the technical package by pressing on the lock. (Fig. 2 and 3)

Snap the new technical package into place on top and press it into the lower catch, ensure that it snaps into place and then reinsert the battery tray.

Spare part name:

XIBU FRESHAIR techn.package

Article no. 492011720000



Fig. 2



Fig. 3



Fig. 4: Baugruppe Technical package

## Battery tray assembly



Fig. 5: Battery tray assembly

### Request:

No blinking signal, dispenser without function

**Possible causes:** Batteries are completely empty, the battery springs are broken, the battery contacts are oxidised

### Solution:

Replace the batteries and/or battery tray

Spare part name:

XIBU FRESHAIR Batteriefach

Article no. 492012300000

## XIBU XL senseFLUID



### **XIBU XL senseFLUID**

Article no.

411030107000

Fig. 1 XIBU xl senseFLUID

## Technical package



Fig. 2 XIBU XL technical package

Spare part name:  
XIBU XL teknikal package

Article no.  
492012180000

## Replacing the technical package assembly

### Tools used:

XIBU key

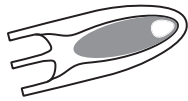

### Request:

Spender ist ohne Funktion

### Solution:

Exchange the technical package

Open the dispenser with the XIBU key.

Remove the battery compartment from the dispenser (Fig. 1).

Remove the technical package by applying pressure to the lock. (Fig. 2 + 3)

Insert new technical package from the top and press into the lower catch. Pay attention to clean locking - „click“.

Then reinsert the battery compartment.

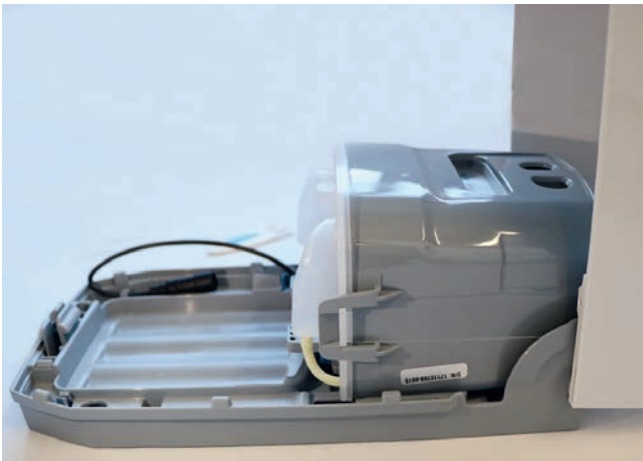

Fig. 1

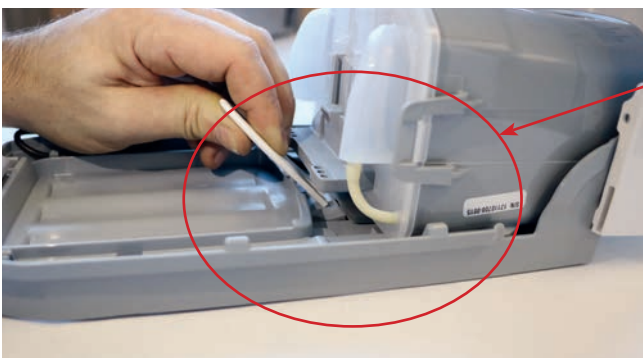

Fig. 2



Fig. 3



## Installation of various XIBU dispensers using two-sided adhesive tape

Process:

- 1.) Clean the mounting areas (back wall and/or mounting panel in the area where the two-sided adhesive tape is to be applied and area it is to be glued to) with SPSE cleaning cloth for dispensers.
- 2.) Leave surfaces to air for approx. 30 seconds
- 3.) Attach two-sided adhesive tape as shown below
- 4.) Position the mounting panel and/or back wall and press the gluing areas together (for a minimum of 30 seconds)

### foam disinfect



**Adhesive tape,  
two-sided, foam/disinf**

Article number:  
492020140000

### SEATCLEANER senseMOISTCARE



**Adhesive tape, two-  
sided, seatCLEANER**

Article number:  
492020130000

### tissuePAPER



**Adhesive tape, two-sided,  
1.6 mm x 20 mm**

(20 mm wide, 1.6 mm thick,  
on a roll)

Article number: 492020150000

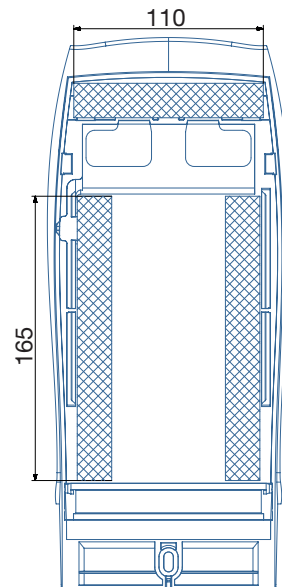

Required tape length  
440 mm

# Installation of various XIBU dispensers using two-sided adhesive tape

## Adhesive solution for XIBU dispensers

### freshAIR



**Adhesive tape, two-sided,  
1.6 mm x 20 mm**

Article number:  
492020150000

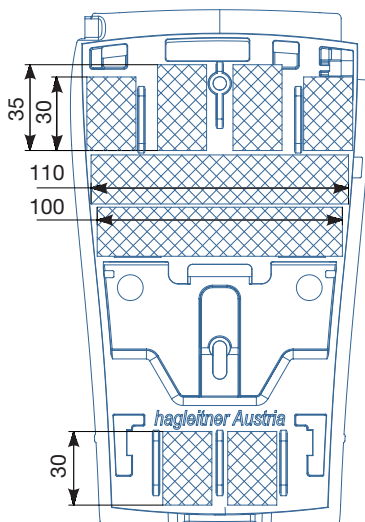

Required tape length  
400 mm

### multiFOLD



**Adhesive tape, two-sided,  
1,6mmx20mm**

Article number:  
492020150000

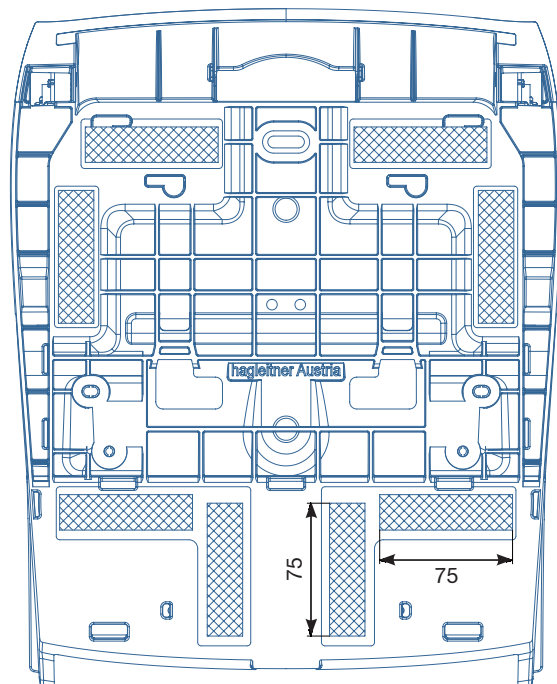

Required tape length 600 mm

# Installation of various XIBU dispensers using two-sided adhesive tape

Adhesive solution for XIBU dispensers

## XIBU XL senseFLUID



**Adhesive tape, two-sided,  
1,6mmx20mm**

Article number:  
492020150000

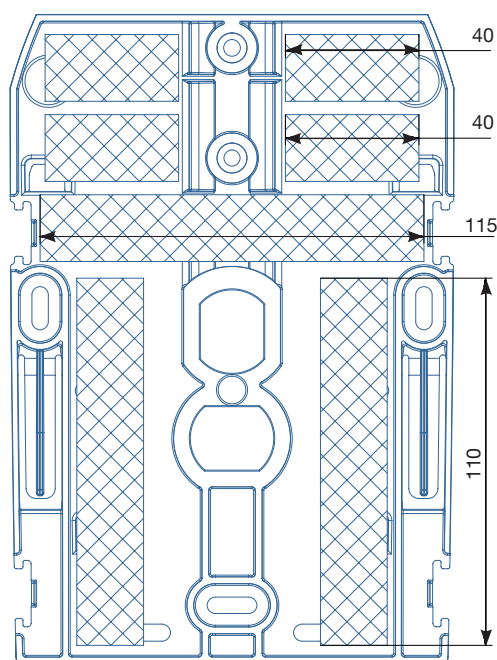

Required tape length 495 mm

## Installation of various XIBU dispenser on mirrors

### Screw mounting of XIBU dispensers on mirrors

When screw mounting a XIBU dispenser onto a mirror, the customer has to provide the necessary spacers and recesses in the mirror.

Hagleitner does not give any warranty for the installation!

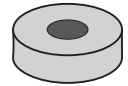

Spacer

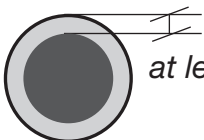
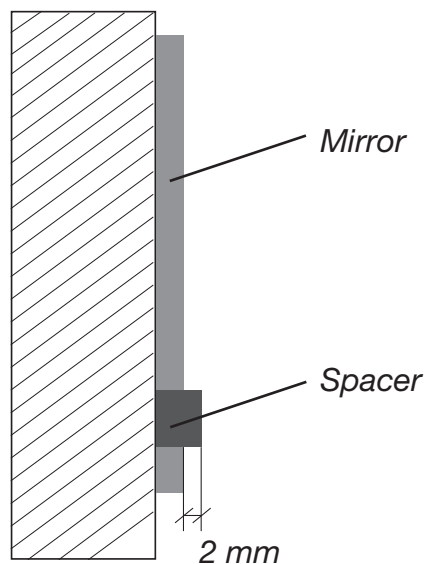
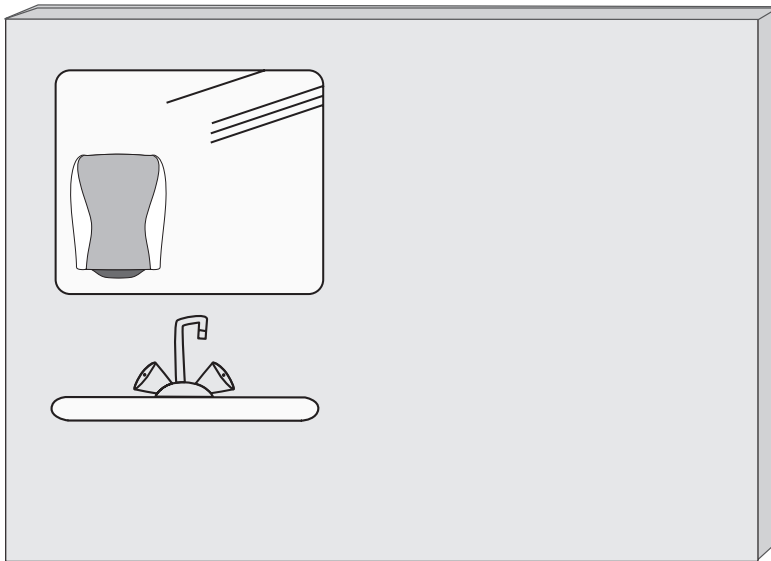

at least 2 mm

**Recommendation for sizing:**

Inner diameter: 5 mm

The hole in the mirror should be at least 4 mm larger than the outside diameter of the spacer.

## NOTES





